

# **CONVERTIBLE-PORTABLE STUMP CUTTER MODEL: CPSC**

## **OPERATING AND ASSEMBLY INSTRUCTION MANUAL**

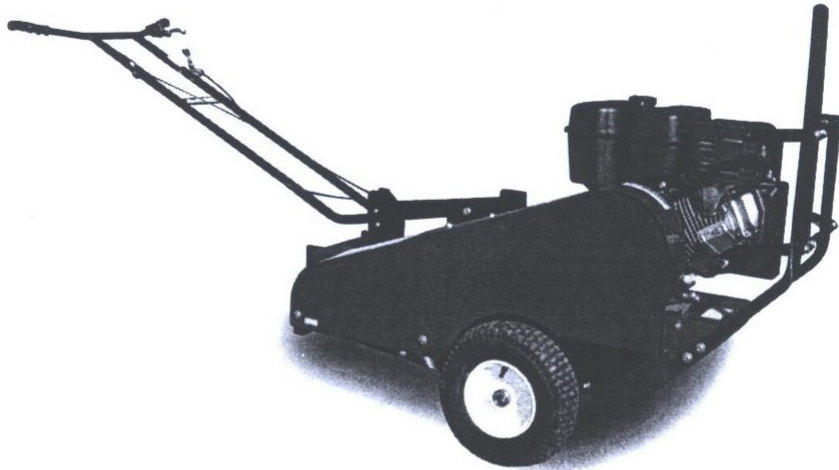

This manual contains information concerning proper and improper operating procedures, warnings, maintenance, troubleshooting, assembly, and tips. Everyone who operates this machine should read these instructions and be thoroughly familiar with them.

**THIS MACHINE IS CAPABLE OF INFLICTING  
SERIOUS INJURY IF OPERATED IMPROPERLY.  
-READ WARNING AND CAUTION LABELS-**

---

**MACKISSIC, INC. P.O. BOX 111, PARKER FORD, PA 19457**

Phone: 610-495-7181

e-mail: [mackissic1@msn.com](mailto:mackissic1@msn.com)

FAX: 610-495-5951

[www.mackissic.com](http://www.mackissic.com)

Part #807-0148  
12/03/01

---

## SECTION I - SAFETY

---



### WARNING



#### Rules for Safe Operation



**WARNING:** To reduce the potential for any injury, comply with the instructions in this manual. Failure to comply with the instructions may result in personal injury.



### TRAINING

Read this owner's manual carefully in its entirety before attempting to assemble or operate this machine. Keep this manual in a safe place for future and regular reference and for ordering replacement parts. The operator must familiarize themselves with the controls when the handle is swung from the front to the rear position, as the throttle and brake controls are reversed.

### INTENDED USE

Never use your stump grinder for any purpose other than chipping or cutting stumps and roots. It is designed for this use and any other use may cause injury.



### DANGER



**DANGER:** *Rotating cutting teeth.* Keep hands and feet out from under the machine when running.



**DANGER:** This machine can **CUT** and **SEVER** parts of your body if they are placed in the area of the cutter head while the unit is running.

Make certain that all safety labels on this equipment are kept clean and in good condition. If you need replacement labels, please order by part number.



091-0057



091-0059



091-0159



091-0161



091-0160

### OPERATOR'S RESPONSIBILITY

- **Never** allow children to operate your stump cutter, or adults without the proper instructions. Keep children, pets, and bystanders a minimum of 20 feet away from your work area. Flying chips can be hazardous.
- **Never** run this machine in an enclosed area since the exhaust from the engine contains carbon monoxide, which is an odorless, tasteless, and deadly poisonous gas.
- **Never** put your hands, feet, face, or any other part of your body near the cutter head while the engine is running.
- **Never** operate your stump cutter while under the influence of alcohol, drugs, or medication. A clear mind is essential for safety.
- **Never** allow a person who is tired or otherwise not alert to operate this machine.
- **Never** operate this machine with any damaged parts or guarding removed.

## SAFETY WEAR

**Never** wear loose clothing or jewelry that can be caught by moving parts of your stump cutter and pull you into it. Keep all clothing away from moving parts. Wear proper headgear to keep hair away from moving parts.

**Always** wear safety glasses provided with your unit at all times while operating your stump cutter. A chip could fly out and hit you in the eye. Be sure your glasses fit properly.

## SAFETY OPERATING PROCEDURE

If it is necessary for any reason to inspect or repair any part of the machine, stop the machine, allow it to cool, disconnect the spark plug wire from the spark plug and move it away from the spark plug before attempting such inspection or repair. Whenever you operate your stump cutter, wearing safety glasses is required. Before each use, check all three controls; brake, throttle, clutch, to be sure they are functioning properly.

The operation of any stump cutter can result in foreign objects being thrown into the eyes, which can result in severe eye damage. Always wear the safety glasses provided with the stump cutter or eye shields before chipping or while performing any adjustments or repairs.

## OPERATE IN A SAFE ENVIRONMENT

Operate equipment only in daylight or in good artificial light.

Extreme care must be taken when operating your machine on a side hill. It could tip, or poor footing could cause an accident. Only operate the machine if you have secure footing. Do not operate the machine parallel to the hill. Always stand uphill from the stump.

- A. Secure handle in front or rear position.
- B. Do not use your machine on muddy or icy surfaces.
- C. Never leave your machine unattended with the engine running.

Thoroughly inspect and clear work area of objects that might be picked up and thrown. Remove all stones, sticks, wires, bones and other foreign objects. Beware of hidden objects located above or below ground, such as electric wires, gas or water lines, and sprinkler systems. **DO NOT BEGIN TO CHIP STUMPS** unless you are sure the area is clear.

1. Know how to turn the machine off.
2. **HANDLE GASOLINE WITH CARE** as it is an extremely flammable fuel.
3. **Check** the fuel before starting the engine. Do not fill the fuel tank indoors, while the engine is running, or while the engine is still hot. Turn the unit off and let the engine cool for at least three minutes before refueling. **Fuel** your stump cutter in a clean area to avoid getting dirt in the gas tank. Do not smoke while refueling. **Fuel tank cap** must be secure at all times except during refueling. **Avoid** spilling gasoline or oil. Wipe the unit clean of any spilled fuel or oil.
4. Store fuel and oil in approved containers, away from heat or open flame, and out of reach of children. Leave 1/2-inch air space at top of fuel tank to allow for expansion of fuel.

## REPAIR AND MAINTENANCE SAFETY

**Never** operate your stump cutter in poor mechanical condition. Periodically check that all nuts, bolts, screws, and belts are tightened to specifications. Be sure all safety guards and shields are in proper position. These safety devices are for your protection.

**Be sure to read and follow** engine owner's manual for engine maintenance and repair.

## BEFORE STARTING ENGINE, ALWAYS CHECK OIL LEVEL



## SECTION II - ASSEMBLY INSTRUCTIONS

### PACKAGE CONTENTS

SKID	POLYBAG
STUMP GRINDER	OWNER'S MANUAL
HANDLE ASSEMBLY	ENGINE MANUAL
POLYBAG	SAFETY GLASSES
	ALLEN WRENCH
	4 EA - CABLE TIES

#### STEP 1 - UNPACKING AND CHECKING CONTENTS

1. Remove all pieces from the skid.
2. Compare all items with the list above.
3. If any parts appear missing or damaged, contact the place where you purchased the unit at once.
4. Assembly should be done on a clean and level surface.

#### STEP 2 - INSTALLING HANDLE SUPPORT

1. Loosen and remove the two bolts mounting the handle support (item #23, pg. 16) to the bumper straps (item #22, pg. 16).
2. Flip the handle support to the upright position with the six adjustment holes above the bumper straps.
3. Replace and tighten the bolts through the bumper straps to the handle support that were removed in step 1

#### STEP 3 - INSTALLING HANDLE ASSEMBLY

The handle assembly is packed with the cables attached, so be careful not to over extend the handle away from the stump grinder and break them loose.

1. Remove bolt and nut (items #50 & #64, pg. 16) from the pivot pin weldment (item #13, pg. 15) and pull it out of the pivot bracket.
2. Carefully pick up the handle assembly (item #14, pg. 16) and put it in place so that the bend is down and the handle grips are at the cutter head end (rear position). **NOTE: Care needs to be taken to prevent the cables from being torn loose, dislodged, or pinched.**
3. Insert pivot pin through the first hole on the handle mount plate (item #9, pg. 16), through the lower handle tube, and into the other hole on the handle mount plate.
4. Secure the pivot pin with the hardware you removed in step 1.

### STUMP CUTTER ACCESSORIES

PART NUMBER	DESCRIPTION
807-0001	Cutter teeth - straight
807-0002	Cutter teeth - 25 degree
807-0003	Cutter teeth - 45 degree
807-0070	Cutter head assembly
807-0092	Green sharpening wheel - 6" x 3/4" x 1"
807-0093	Carbide flap wheel - 4 1/2" x 7/8"
807-0094	Sharpening kit - cutter head assy, green wheel, four flap wheels

#### STEP 4 - SECURING THE CABLES

1. Four cable ties have been provided for fastening the cables to the handlebar after it has been installed. Refer to figure 2 for the correct mounting points of the cable ties.
2. Attach the clutch cable in the center of the handlebar mounting pivot at point #1. Loop the cable so it provides plenty of clearance from the belt guard and does not bind when the handle is rotated to the front position. This attachment also keeps the cable away from the idler pulley.
3. With the handle in the rear position, opposite the cutter head, install the other cable ties at points 2, 3 and 4 (fig. 2).
4. Swing the handles from the front to the rear position while checking to make sure the cables do not bind or become kinked.

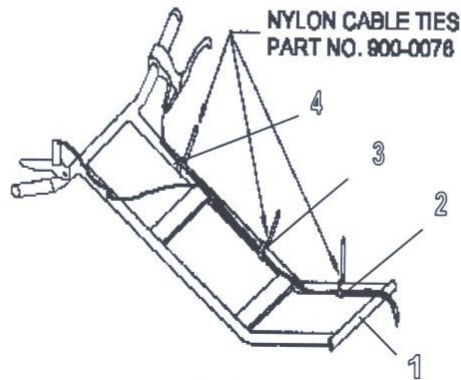

fig. 2

#### STEP 5 - POSITIONING THE HANDLE

1. You can secure the handle in the front or rear position as well as adjust for height with the clevis pins (item #78, pg. 15) and hair cotters (item #79, pg. 15) provided as shown in figure 3.
2. **Note:** Brake, throttle and clutch controls will be reversed when handle is switched from front to rear position.

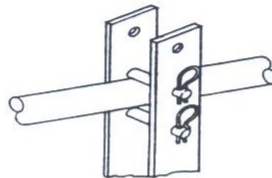

fig. 3

**BEFORE STARTING ENGINE, ALWAYS CHECK OIL LEVEL**

**GREASE CUTTER HEAD BEARINGS  
SEE MAINTENANCE SECTION FOR INSTRUCTION**

---

## SECTION III - LUBRICATION & ENGINE START UP

---

FOR INFORMATION ABOUT:

1. OIL
2. FUEL
3. STARTING
4. STOPPING
5. RECOMMENDED MAINTENANCE
6. SERVICE
7. STORAGE
8. ENGINE WARRANTY INFORMATION

REFER TO THE ENGINE OWNER'S MANUAL.

**THE ENGINE ON YOUR STUMP GRINDER HAS BEEN SHIPPED DRY.**

**BE SURE TO SERVICE THE ENGINE ACCORDING TO THE  
ENGINE OWNER'S MANUAL PRIOR TO STARTING.**

**FAILURE TO DO SO CAN RESULT IN DAMAGE NOT WARRANTED BY  
THE ENGINE MANUFACTUROR.**

**WARNING:** Do not fill closer than ½" from the top of the fuel tank to prevent spills and to allow for fuel expansion. If gasoline is accidentally spilled, move the mower away from the area of the spill. Avoid creating any source of ignition until gasoline vapors have disappeared.

**CAUTION:** Experience indicates that alcohol blended fuels (gasohol, ethanol, methanol) can attract moisture which leads to separation and formation of acids during storage. Acidic gas can damage the fuel system or an entire engine while in storage. To avoid engine problems, the fuel system should be empty before storage for periods over 30 days. For more information, refer to the engine owner's manual. Use fresh fuel each season. Never use engine or carburetor cleaner products in the fuel tank or permanent damage may result.

**ALWAYS CHECK OIL LEVEL PRIOR TO STARTING  
THE STUMP GRINDER.**

---

## SECTION IV-OPERATION

---

These operating instructions are designed to help you get the most out of your stump cutter.

1. It is suggested that tall stumps always be cut to near ground level with a chain saw prior to cutting with this machine. This is a big time saver.
2. Use a mattock or other digging tool to remove dirt and stones from around the stump as deep as you intend to cut. This is important to prolong the life of the cutter teeth. Stones that are solidly embedded in the stump and can't be seen will only dull the cutting teeth. The loose stones should be removed since they can chip a tooth or be thrown by the cutter head. Your cutter head is affixed with teeth of a mining grade tungsten carbide. It will continue to cut in spite of stones, but the fewer stones it strikes-the better.
3. Select the desired handle location for the job. Remove the hair cotter and the clevis pin (items #78, #79, pg. 16). Swing the handle (item #14, pg. 16) over to convert the stump cutter to a front or rear cutter. If the stump is close to a building or fence, have the cutter head in front. If the stump is in the open, you may find it is easier to chip with the cutter head in the rear. You can also change the height of the handles by positioning the clevis pin in one of several locations. Always secure the clevis pin with the hair cotter pins. (Figure 3 pg. 6).

**NOTE: Front Position – Operator position and handle on engine end of machine, farthest from cutter head.**

**Rear Position – Operator position and handle on cutter head end of machine.**

4. If the ground is very soft, place a sheet of plywood around the stump, especially on the sides. Pull or push the machine up onto the stump so that about 1/3 (3" or 4") of the cutter head is nearly touching the stump.
5. Once the machine is positioned over the stump, squeeze the brake handle to lock the wheel. The brake locks one wheel only and allows you to make a sweeping motion with the cutter head. You can hold the brake on with one hand or lock it in position by depressing the brake handle lock (item C, Figure 6). To unlock the brake, simply squeeze the lever and release.

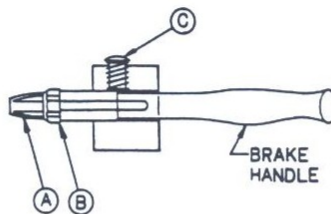

fig. 6

fig. 6



6. Move kickstand to mid-position for rear-cutting and top position for front cutting. While not in use, move the kickstand to the down position. This keeps the cutter head off the ground, preventing damage to the cutter teeth.  
**NOTE: Never adjust the kickstand while the cutter head is in motion.**
7. Move throttle control to the run position. The engine will stall if you engage the cutter head while the engine is in idle.
8. Hold operator presence handle down against the rest of handle. This will engage the cutter head. When the operator presence handle is released, the cutter head will stop in less than two seconds. Test the unit before operating to make sure the clutch is performing properly. If the clutch does not perform properly discontinue use immediately.

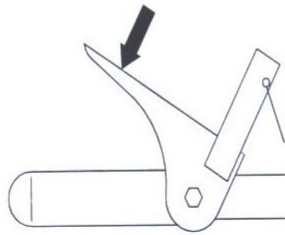

fig. 7

9. Start to cut the stump at the extreme left (rear position) or extreme right (front position). Swing the cutter head across the stump, cutting approximately 2" of wood at each pass. As you become more familiar with your machine, you will be able to cut left to right and right to left. The hardness of the wood and the sharpness of the teeth will dictate how deep and how fast you cut. See figure 8.

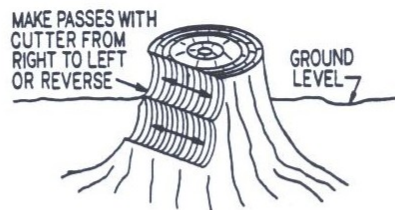

fig. 8

10. At the end of each pass, allow the engine to recover to full speed. Release the brake to push or pull the cutter further into the stump, re-lock the brake and continue cutting.
11. Continue to cut across the stump until entire stump is at ground level. To cut below ground level, position cutter head in the center of the stump and work towards the outer edges.

---

## SECTION V - MAINTENANCE

---

### LUBRICATION OF THE ENGINE

Check engine oil level regularly-**WHILE THE UNIT IS IN A LEVEL POSITION**. Check the oil every five hours of operation and before each usage. Stop engine and wait several minutes before checking oil level. With engine level:

1. Remove the oil filler plug and check oil level. It should be to the top of the fill plug.
2. If the level is low, fill to the top of the fill plug.

Change oil after the first five hours of operation and every 25 hours thereafter. Refer to the engine manual enclosed with this unit for additional information on your engine.

### AIR CLEANER

Refer to the engine manual for additional information on the air filter

1. Do not operate engine if air cleaner or cover directly over carburetor air intake is removed. Removal of such parts could create a fire hazard.
2. Do not use flammable solutions to clean the air filter.

### BEARINGS

Grease cutter head bearings after every use. Greasing should be done after unit has been washed down as water pressure can remove grease from the bearings. The greasing process will remove any water that has penetrated the bearing. Lubricate bearings with a #2 lithium based grease while manually rotating cutter head until fresh clean grease is seen purging from the bearing seals.

### BELT TENSION

Check belt tension frequently. This is especially important in the first one hour of use. Once the belt is "seated" and initially stretched (approximately two hours), recheck the tension. You should check the tension each time you use the machine. To test belt tension, push down on the belt at mid span with moderate pressure. The belt should move approximately 1/2".

To adjust belt tension:

1. Loosen the four motor bolts
2. Tighten or loosen the adjustment nut on the belt tensioner (item #36, pg. 15) until desired belt tension is reached.
3. Retighten the four motor bolts.

### CALIPER BRAKES

The brake is needed to prevent the machine from moving away from the stump during cutting. To adjust the brake:

1. Loosen the locking nut on the brake handle. (Item B, fig. 9)
2. Turn the brake adjuster (Item A, fig. 9) out, away from the handle, a few turns.
3. Continue to check to see if the brake is holding.
4. When the brake "holds", the correct adjustment is reached. Re-tighten the locking nut. (Item B, fig. 9).

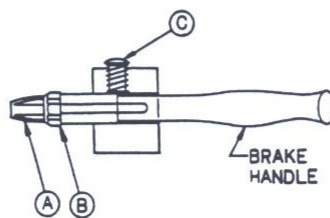

fig. 9

1. If correct adjustment cannot be achieved at the handle, turn the brake adjuster all the way in and adjust brake tension at the brake caliper.
2. To adjust brake at caliper (item #26, pg. 16), loosen locking nut (Item B, fig. 10). Turn adjusting screw (Item A, fig. 10) in until brake is holding. Retighten locking nut (Item B, fig. 10).

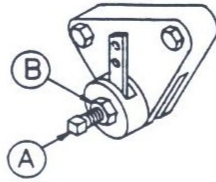

fig. 10

### CLUTCH ADJUSTMENT

Your Stump Grinder is equipped with a brake clutch that controls the motion of the cutter head. When engaged the clutch allows the cutter head to spin, when disengaged the clutch will stop the cutter head in under 2 seconds. It is critical that the clutch control cable be adjusted properly.

To adjust the clutch control cable:

1. Remove belt guard and disconnect clutch control cable from spring attached to clutch engagement lever (item C, fig. 11).
2. With engagement lever fully forward measure 1 ½" backwards from the left hand edge of the lever and make a mark on the clutch housing.
3. Re-connect the clutch control cable and adjust the jam nuts (item A, fig. 11) forwards or backwards as necessary so that the lever does not pull backwards.
4. Compress the operator presence handle and check that left hand edge on the engagement lever moves to the mark on the clutch housing.
5. Adjust cable accordingly if lever moves to the left or right of the mark.
6. If more adjustment is needed, move the cable end support (item B, fig. 11) as necessary.

Clutch cable tension should be checked periodically along with belt tension.

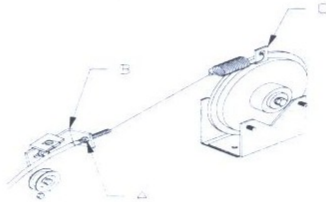

fig. 11

### CLUTCH SERVICING

The clutch is shipped from the factory assembled and adjusted. No internal adjustment is available to the end user. For service, return the clutch to the factory.

### STORAGE

Never store your stump grinder indoors or in an enclosed, poorly ventilated area if gasoline remains in the tank. Fumes may reach an open flame, spark or pilot light from a furnace, water heater, clothes dryer, cigarette, etc. When not in use, your machine should be stored out of reach of children with the spark plug removed. Always allow the engine to cool before storing or covering. For long periods of storage (over winter), please refer to the engine owner's manual.



---

## SECTION VI – CUTTER HEAD

---

PERIODICALLY THE COMPLETE CUTTER HEAD ASSEMBLY, INCLUDING THE DRIVE SHAFT WELDMENT AND BEARINGS, SHOULD BE REMOVED AND INSPECTED FOR WEAR.

1. The cutter head should be inspected for, loose or missing cap screws, cracking, or loose or missing teeth.
2. The drive shaft weldment should be inspected for cracking or wear of shaft and all welds.
3. Bearings should be inspected for wear, check to make sure there is not excessive play and that the inner bearing rotates smoothly. Check to make sure both snap rings are in place and securing properly. Also make sure set screws are tight and secured with Loctite 243.
4. Inspect drive pulley for excessive wear, pulley should be mounted flush with the end of the drive shaft.
5. Before re-installing check the bearing mounting holes for wear or elongating. If this occurs the cutter head support weldment should be replaced. Bearing mounting bolts should be checked for tightness after every use.
6. The cutter head is fastened to the mounting flange on the spindle with four 3/8-16 x 1-3/4" bolts. Be sure to check them frequently for tightness. (Figure 12)

### TEETH

Your stump cutter is equipped with carbide tipped teeth. (Items 24d, 24e, 24f, pg. 16) Carbide retains its sharpness longer, cuts faster and smoother and can withstand heat, but they will wear. Sharpen the teeth before excessive wear or when they look dull or rounded. Check the teeth on the cutter head after each use. Always check the 45-degree tooth first because it is the most abused being a "digger and leader". Any cutter tooth with less than a 10-degree relief (see fig. 15, pg. 14) will cause poor performance, smoke and burn marks. By keeping the teeth sharp, you will prevent frustration at the job site. It only takes a few minutes to touch them up before you go out on a job. If the unit receives heavy use, a second cutter head assembly can be purchased as a back up while the other head is being sharpened.

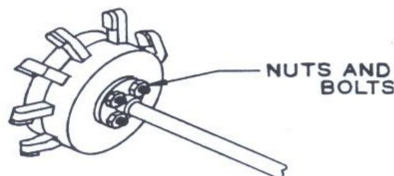

fig. 12

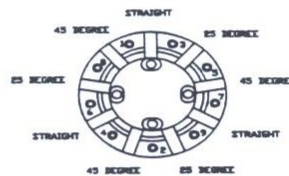

fig. 13

### FOR PROPER OPERATION:

1. Teeth should be installed according to the pattern shown in figure 13 above.
2. Cutter head must never be run with a missing or damaged tooth.

**CAUTION:** Excessive vibration is usually a result of broken or missing teeth. Stop engine, disconnect spark plug wire and inspect.

### SHARPENING SCHEDULE

1. After each use- touch up teeth using #807-0093, carbide flap wheel, and a right angle grinder.
2. Every 50 hours, remove cutter head and sharpen teeth on a bench grinder using #807-0092, green sharpening wheel and a regular gray grinding wheel.
3. Every 250 hours- Replace teeth

**Caution:** Above schedule is a recommended only. Actual results may vary.



**WARNING: WHEN SHARPENING TEETH, ALWAYS WEAR EYE PROTECTORS AND A DUST MASK OR RESPIRATOR. CARBIDE DUST CAN BE DANGEROUS IF INHALED.**

### TO SHARPEN

Teeth can be removed and sharpened individually or while still attached to the cutter head.

1. Remove entire cutter head (see figure 12) by removing the four 3/8"-16 nuts and bolts.
2. To remove the teeth from the cutter head, remove the 9 cap screws using the 5/16" Allen wrench provided.
3. Tap any of the 9 teeth with a soft hammer to "pop" the cover off the cutter body.
4. Remove the 9 teeth from their slots.
5. Any bench-type or pedestal style grinder with a "Green wheel" (silicon carbide grinding wheel or diamond wheel) may be used on the carbide teeth. A regular gray wheel (coarse grinding wheel) is needed for grinding the steel relief. It is best if you can set up the grinder with a coarse wheel on one side and "Green Wheel" on the other side.
6. Teeth may be ground free hand since precision is not important. Any variance between teeth will not be noticed.
7. Using the "Green Wheel", grind the end of the carbide until the edge is sharp. Avoid grinding on the face of the carbide, which would reduce its thickness and weaken it, making it more susceptible to cracking and chipping. (Figure 14)

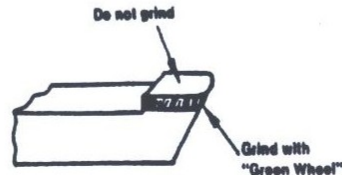

fig. 14

8. As the end of the carbide is ground away, you will have to grind "relief" on the square steel shank. The steel must be ground with the regular coarse grinding wheel and not the "Green Wheel".
9. Although the angle is not critical, always grind the tooth so that there is enough "relief" under the carbide edge (minimum 10 degrees). (Figure 15)



fig. 15

10. The tooth may continue to be ground until the carbide has approximately 1/4" remaining (Figure 16).

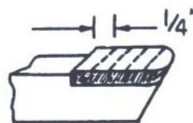

fig. 16