

Model: CSX2000

Part number: 90063257

Year: 2022

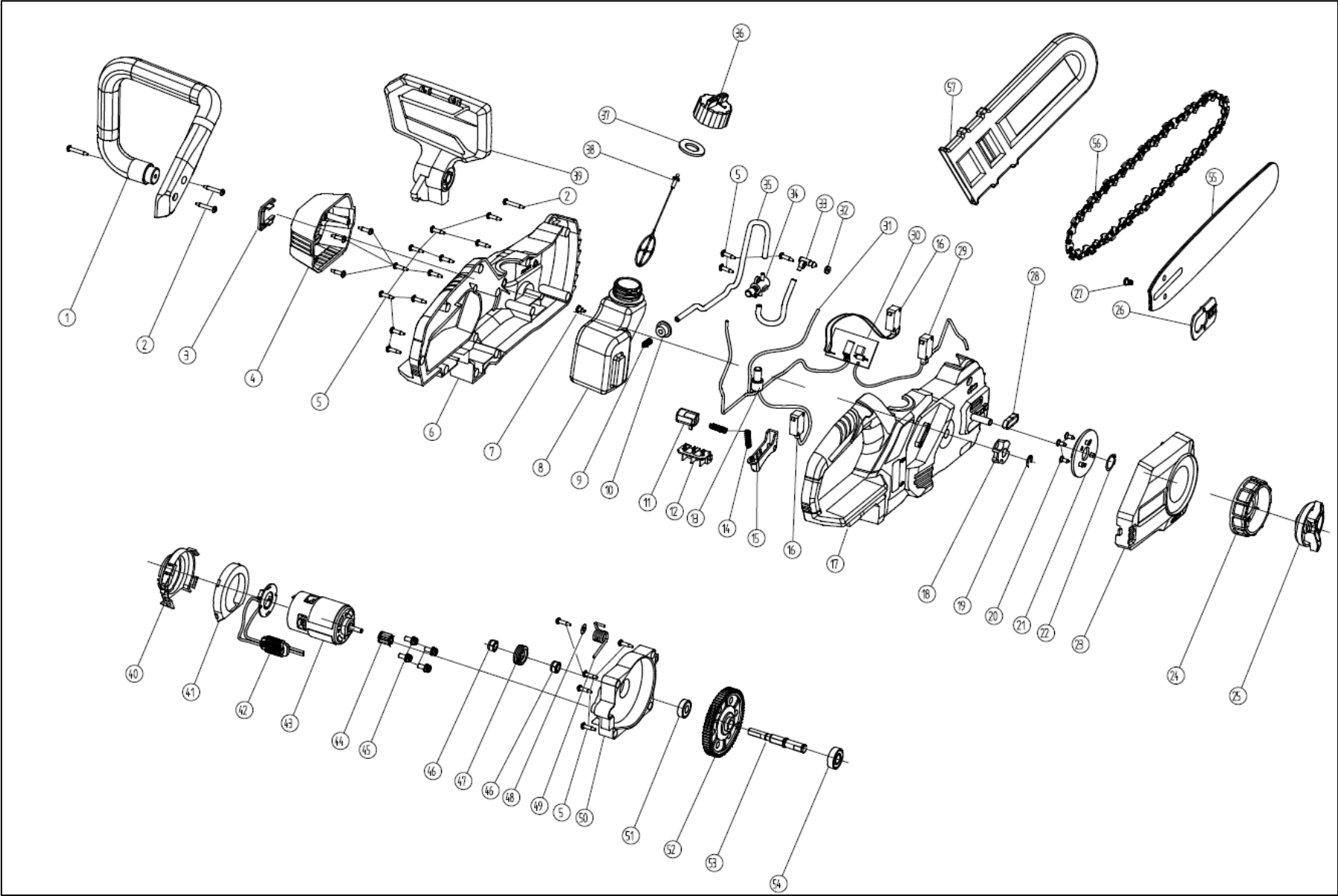

POS	QTY	PARTNUMBER	BESKRIVELSE	DESCRIPTION
1	1	448661	HÅNDTAG	SUB-HANDLE
2	4	448619	SKRUE	INNER PLUM PAN HEAD SELF - TAPPING SCREW
3	1	448514	PYNTELISTE	U-SHAPED DECORATIVE PIECES
4	1	448662	COVER	MOTOR COVER
5	22	448526	SKRUE	INNER PLUM PAN HEAD SELF - TAPPING SCREW
6	1	448663	MOTORHUS VENSTRE	LEFT HOUSING
7	1	448636	UDLUFTNINGSVENTIL	BREATHER VALVE
8	1	448664	OLIETANK	OIL CAN
9	1	448665	FILTER	SPRING FILTRATION
10	1	448666	PAKNING	OIL OUTLET SEALING RING
11	1	448667	LÅSEKNAP	SELF-LOCK BUTTON
12	1	448520	STIK	SOCKET
13	1	448668	LEDNINGSFORBINDER	WIRE CONNECTOR
14	2	448518	FJEDER	PUSH ROD SPRING
15	1	448669	UDLØSER	SWITCH TRIGGER
16	2	448531	KONTAKT	MICRO SWITCH
17	1	448670	MOTORHUS HØJRE	RIGHT HOUSING
18	1	448651	TANDHJUL	SPROCKET
19	1	448652	HESTESKORING	E CHECK RING
20	3	448671	SKRUE	SELF-TAPPING SCREW PAN HEAD CROSS GROVED
21	1	448672	SKIVE	SPIRAL LAMINA
22	1	448673	LÅSERING	EXTERNAL CIRCLIP
23	1	448674	SIDECOVER	SIDE COVER
24	1	448675	HÅNDTAG KÆDEJUSTERING	ADJUSTING ROTARY KNOB
25	1	448676	DREJELÅS	IMPACT ROTARY KNOB
26	1	448677	JUSTERSTYKKE	CHAIN ADJUSTING PLATE
27	1	448678	SKRUE	CROSS GROOVED DISC HEAD WITH BACKING MAC
28	1	448629	PAKNING	OIL OUTLET SEALING RING
29	1	448679	KONTAKT	MICRO SWITCH
30	1	448680	PRINTPLADE	PCB BOARD
31	3	448624	LEDNING	INTERNAL WIRE
32	2	448681	PAKNING	TUBING JOINT SEAL RING
33	1	448682	OLIEFORBINDER	OIL CONNECTION
34	1	448683	OLIEPUMPE	OIL PUMP
35	2	448642	OLIESLANGE	OIL TUBE
36	1	448684	SKRUELÅG	OIL CAN COVER
37	1	448685	PAKNING	O SHAPED SEAL RING
38	1	448686	HOLDER FOR SKRUELÅG	OIL CAN ROPE
39	1	448687	KÆDEBREMSE HÅNDTAG	FRONT DAMPER
40	1	448688	SKÆRM	LEFT WINDSHIELD RING
41	1	448689	MOTORHOLDER	RIGHTWINDSHIELD RING
42	1	448690	KONTROLPANEL	ANTI-INTERFERENCE PCB INDUCTIVE COMPONEN
43	1	448691	MOTOR	887 MOTOR
44	1	448692	TANDHJUL	PINION
45	4	448693	BOLT	CROSS GROOVED DISC HEAD THREE COMBINATIO

POS	QTY	PARTNUMBER	BESKRIVELSE	DESCRIPTION
46	2	448694	MØTRIK	HEXAGON CHECK NUT
47	1	448695	OLIE-DEL	OIL BUMP WORM
48	1	448696	SKIVE	ADJUSTING KNOB WASHER
49	1	448697	FJEDER	LOCKING TORSIONAL SPRING
50	1	448698	GEARHUS	GEAR CASE
51	1	448699	KUGLELEJE	DEEP GROOVE BALL BEARING
52	1	448700	GEARHJUL	BIG GEAR WHEEL
53	1	448701	AKSEL	OUTPUT SHAFT
54	1	448702	KUGLELEJE	DEEP GROOVE BALL BEARING
55	1	441631	SVÆRD 100SDEA041	GUIDE BAR
56	1	448703	SAVKÆDE OREGON 91PX040X	CHAIN
57	1	427125	BESKYTTELSE TIL MOTORSVÆRD 10"	GUARD 10"