

POS	QTY	PARTNUMBER	BESKRIVELSE	DESCRIPTION
1	13	441667	SKRUE ST3,9X16	SCREW ST3.9*16
2	1	441956	BAGDÆKSEL	REAR COVER
3	1	441957	FORBINDELSSTANG	ROCKERARM CONNECTING ROD
4	2	441958	OPHÆNG FOR BATTERIHOLDER	BATTERY COMPARTMENT COVER ROCKERARM
5	4	441959	KABELSKO	CABLE PRESSING PLATE
6	36	441960	SKRUE ST3,9X12	SCREW ST3.9×12
7	4	441961	BOLT M4X20	SCREW M4×20
8	1	441962	SIKKERHEDSKONTAKT	SAFETY SWITCH
9	2	441963	BESLAG	CONNECTION LAYERING
10	1	441964	BATTERIHOLDER	BATTERY COMPARTMENT SEAT
11	2	441965	MAGNET	MAGNET
12	1	441966	STIK FOR BATTERIHOLDER	BATTERY COMPARTMENT SEAT CONNECTOR
13	1	441967	PLASTIK DÆKSEL VENSTRE	LEFT PLASTIC COVER
14	1	441968	BATTERIDÆKSEL	BATTERY COMPARTMENT COVER
15	1	441969	SIKKERHEDSLÅS	SAFE LOCK
16	1	441970	PLASTIK DÆKSEL HØJRE	RIGHT PLASTIC COVER
17	1	441971	KABEL	MAIN CONTROL LINE
18	4	441972	LÅSEMØTRIK M4	LOCKING PLATE M4
19	1	441973	STYRBOKS	SINGLE PACKAGE HAND-PUSH CONTROLLER
20	2	441974	BATTERIHOLDER	BATTERY BUNKER
21	4	441658	SELVLÅSENDE KONTAKT	C501 BATTERY PACK RESET PILLAR
22	4	441657	FJEDER	B521 BATTERY BUNKER SPRING
23	2	441655	BATTERIKONSOL	C501 BATTERY BUNKER SOCKET
24	3	441656	STIK	C501 PLUG
25	2	441975	BATTERIHOLDER BUND	BATTERY BUNKER SEAT
26	1	441976	SIKRINGSKABEL	SAFETY SWITCH CONNECTING WIRE A
27	1	441977	STRØMKABEL	POWER CONNECTING WIRE A
28	4	441978	NYLON LÅSEMØTRIK M8	NYLON LOCKING NUT M8
29	1	441979	DÆKSEL FOR MOTOR	MOTOR BARREL
30	1	441980	MOTOR	MAIN MOTOR
31	4	441981	NYLON LÅSEMØTRIK M6	NYLON LOCKING NUT M6
32	1	441982	HOLDER FOR MOTOR	MOTOR SEAT

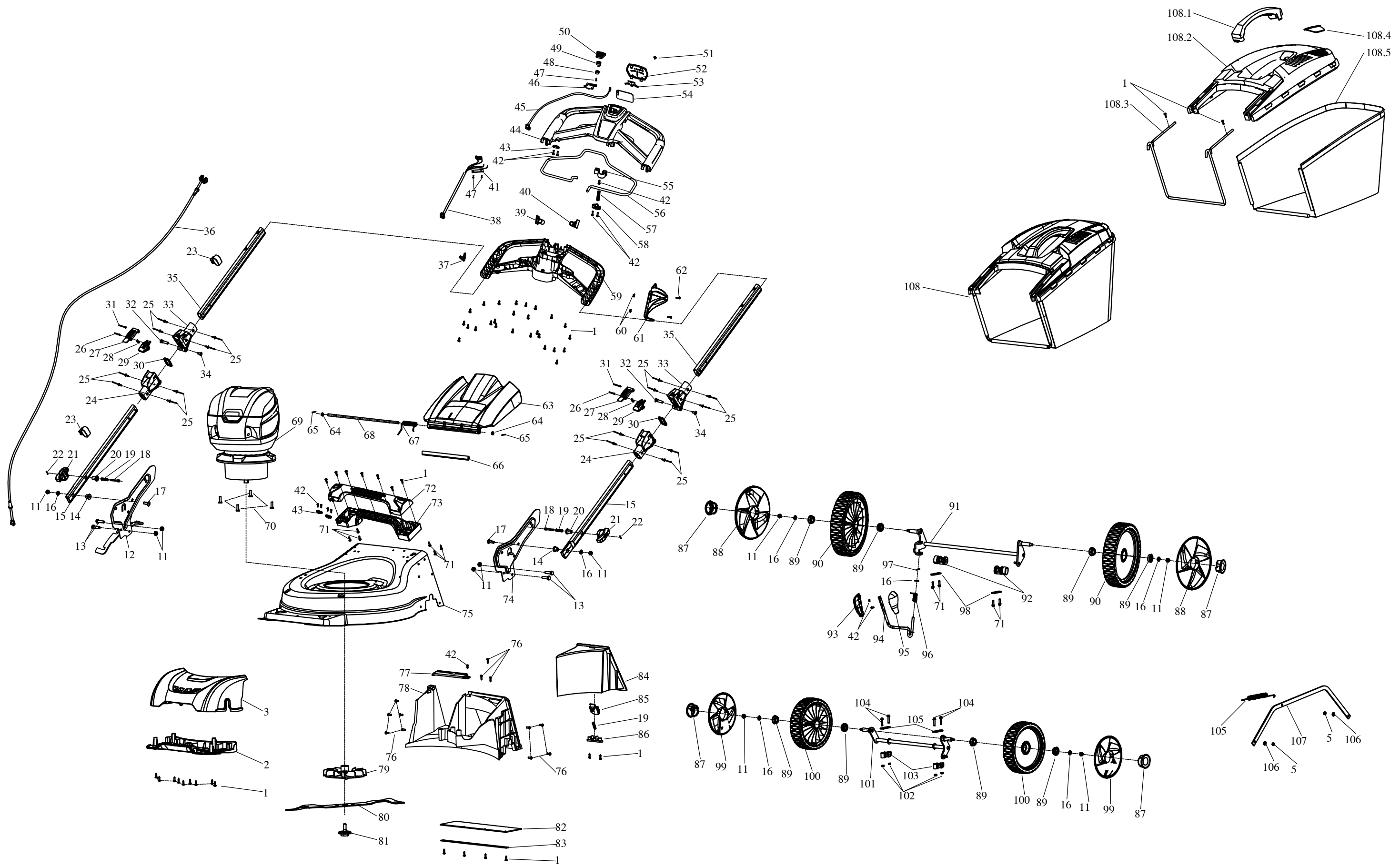

POS	QTY	PARTNUMBER	BESKRIVELSE	DESCRIPTION
1	50	441667	SKRUE ST3,9X16	SCREW ST3.9*16
2	1	441983	SKÆRM NEDERST	GRASS COMB
3	1	441984	FORSKÆRM	FRONT CHASSIS SHIELD
4	2	441985	BOLT M6X12	BOLT M6×12
5	2	441981	NYLON LÅSEMØTRIK M6	NYLON LOCKING NUT M6
11	10	441978	NYLON LÅSEMØTRIK M8	NYLON LOCKING NUT M8
12	1	441986	STYRHOLDER HØJRE	RIGHT HANDRAIL RETAINING PLATE ASS'Y
13	4	441987	BOLT M8X16	BOLT M8×16
14	2	441988	BØS	SPINDLE FIXING SLEEVE
15	2	441989	STYRSTANG NEDERST	LOWER HANDRAIL
16	7	441990	PAKNING	FLAT GASKET 8
17	2	441991	BOLT M8X20	BOLT M8×20
18	2	441992	BOLT FOR FASTSPÆNDING AF STYRRØR	KNOB SHAFT
19	4	441993	KNOPFJEDER	KNOB SPRING
20	2	441994	BØS	KNOB SHAFT SLEEVE
21	2	441995	FINGERSKRUE	KNOB
22	2	441996	FJEDERSPLIT 2X14	SPRING PIN 2×14
23	2	441997	KABELHOLDER	CABLE CLAMP
24	2	441998	SAMLELED NEDERST	LOWER HANDRAIL CONNECTOR
25	16	441639	NAGLE 4X13	RIVENT 4*13
26	2	441999	SPLIT 3X28	CYLINDRICAL PIN 3×28
27	2	442000	VIPPEARM	ROCKERARM
28	2	442001	LÅSEFJEDER	LATCH SPRING
29	2	442002	LÅS	LATCH
30	2	442003	SPÆNDESKIVE	CONNECTOR WASHER
31	2	442004	SPLIT 3X36	PIN 3×36
32	2	442005	LÅSEMØTRIK	LOCK NUT
33	2	442006	SAMLELED ØVERST	UPPER HANDRAIL CONNECTOR
34	2	442007	LÅSEBOLT	LOCK SCREW
35	2	442008	STYRSTANG ØVERST	UPPER HANDRAIL
36	1	442009	KABEL	CONTROL LINE
37	1	442010	KROG	HOOK
38	1	442011	KABEL	CONTROL SWITCH WIRING
39	1	442012	KONTAKTDEL HØJRE	RIGHT TRIGGER PLUG
40	1	442013	KONTAKTDEL VENSTRE	LEFT TRIGGER PLUG
41	1	442014	KONTAKT TÆND/SLUK	SWITCH PRESSING PLATE
42	12	441960	SKRUE ST3,9X12	SCREW ST3.9×12
43	3	441959	KABELSKO	CABLE PRESSING PLATE
44	1	442015	HÅNDTAG ØVERST	HANDLE TOP COVER
45	1	442016	KABEL FOR START KORT	CONTROL PANEL WIRING
46	1	442017	KONTAKT	SWITCH
47	3	442018	SKRUE 2,9X9,5	SCREW ST2.9×9.5
48	1	442019	BESLAG	MAIN MOTOR TRIGGER KEY
49	1	442020	TRYKFJEDER	ACTIVATION KEY RESET SPRING
50	1	442021	KONTAKT FOR START	MAIN MOTOR ACTIVATION KEY
51	1	441659	KNAP	DB521 MICRO BUTTON

POS	QTY	PARTNUMBER	BESKRIVELSE	DESCRIPTION
52	1	442022	PANEL SKÆRM	DISPLAY PANEL COVER
53	1	442023	PAKNING FOR PANEL	CONTROL PANEL SHADING GASKET
54	1	442024	KONTROLPANEL	CONTROL PANEL
55	1	442025	MOTOR KONTAKT	MAIN MOTOR SWITCH TRIGGER
56	1	442026	BØJLE FOR STOP	MAIN MOTOR CONTROL LEVER
57	1	442027	FJEDER	CONTROL LEVER LIMIT SPRING
58	1	442028	BØJLESTOP	LEVER LIMITER
59	1	442029	HÅNDTAG NEDERST	HANDLE LOWER CASING
60	2	442030	MØTRIK M5	NUT M5
61	1	442031	KOPHOLDER	WATER BEVERAGE HOLDER
62	2	442032	BOLT M5X12	SCREW M5×12
63	1	442033	UDKASTERKLAP	GRASS BAFFLE
64	2	442034	LÅSERING Ø6	CIRCLE 6
65	2	442035	SPLIT 1,5X23	PIN ?1.5×23
66	1	442036	TÆTNING	SEALING STRIP
67	1	442037	FJEDER	GRASS BAFFLE SPRING
68	1	442038	AKSEL	GRASS BAFFLE SHAFT
69	1	442039	MOTOR	SINGLE PACKAGE HAND-PUSH ENGINE
70	4	441987	BOLT M8X16	BOLT M8×16
71	10	442040	SKRUE ST4,8X20	SCREW ST4.8×20
72	1	442041	BÆREHÅNDTAG ØVERST	CARRYING HANDLE TOP COVER
73	1	442042	BÆREHÅNDTAG NEDERST	CARRYING HANDLE BOTTOM SEAT
74	1	442043	STYRHOLDER VENSTRE	LEFT HANDRAIL RETAINING PLATE
75	1	442044	KLIPPESKJOLD	CHASSIS
76	12	442045	SKRUE ST4,8X12	SCREW ST4.8×12
77	1	442046	BESKYTTER	CHASSIS GUARD
78	1	442047	SKÆRM FOR KLIPPERSKJOLD	CHASSIS SHIELD
79	1	442048	BLÆSEHJUL	FAN
80	1	442049	KNIV	BLADE
81	1	442050	KNIVBOLT	BLADE LOCK BOLTS
82	1	442051	BAGSKÆRM	REAR BUMPER FUR
83	1	442052	HOLDER OR BAGSKÆRM	REAR BUMPER FUR PLATE
84	1	442053	BIOPLUG	MULTCH PLUG
85	1	442054	BIOPLUG SIKRING	MULTCH PLUG LOCKING PLATE
86	1	442055	HOLDER FOR FJER	MULTCH PLUG SPRING HOLDER
87	4	442056	NAVKAPSEL	SMALL WHEEL COVER
88	2	442057	HJULKAPSEL BAGERST 10"	10IN. BIG WHEEL COVER
89	8	442058	HJULLEJE	STAMPING BEARINGS
90	2	442059	BAGHJUL 10"	10IN. TIRE COMP.
91	1	442060	BAGAKSEL	REAR WHEEL ROD COMP.
92	2	442061	LÅSE KRAVE FOR BAGAKSEL	REAR WHEEL ROD FIXING SLEEVE

POS	QTY	PARTNUMBER	BESKRIVELSE	DESCRIPTION
93	1	442062	KNOP FOR HØJDEJUSTERING HØJRE	ADJUST HANDLEBAR FRONT COVER
94	1	442063	HØJDEJUSTERING	HEIGHT ADJUST LEVER
95	1	442064	KNOP FOR HØJDEJUSTERING VENSTRE	ADJUST HANDLEBAR REAR COVER
96	1	442065	FJEDER FOR HØJDEJUSTERING	HEIGHT ADJUST LEVER SPRING
97	2	442035	SPLIT 1,5X23	PIN ?1.5×23
98	4	442066	LÅSEPLADE FOR HJULAKSEL	WHEEL ROD PRESSING PLATE
99	2	442067	HJULKAPSEL FORREST 8"	8IN.BIG WHEEL COVER
100	2	442068	FORHJUL 8"	8IN. TIRE COMP.
101	1	442069	FORAKSEL	FRONT WHEEL ROD COMP.
102	4	442070	LÅSEMØTRIK NYLON M5	NYLON SELF-LOCKING NUT M5
103	2	442071	HOLDER FOR FORAKSEL	FRONT WHEEL ROD HOLDER
104	4	442072	BOLT M5X30	BOLT M5×30
105	1	442073	FJEDER FOR HØJDEJUSTERING	CONNECTING ROD SPRING
106	2	442074	PAKNING M5X30	FLAT GASKET 6
107	1	442075	FORBINDER	CONNECTING ROD
108	1	442076	GRÆSOPSAMLER KOMPLET	GRASS BAG ASS'Y
108.1	1	442077	HÅNDTAG FOR GRÆSOPSAMLER	GRASS BAG TOP HANDLE
108.2	1	442078	GRÆSOPSAMLER TOP	GRASS BAG TOP COVER
108.3	1	442079	BØJLE FOR GRÆSOPSAMLER	GRASS BAG BRACKET
108.4	1	442080	INDIKATOR FOR FYLDT GRÆSOPSAMLER	STRAW INDICATOR
108.5	1	442081	GRÆSOPSAMLER POSE	STRAW BAG